



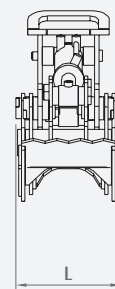
 Pinze per movimentazione tronchi e materiali vari
 Grabs for logs' and different materials' handling
 Pincés pour la manipulation des troncs et des matériaux divers

 Holzgreifer und verschiedenen Materialumschlag
 Pinzas para troncos y materiales diversos
 Грейфер для круглого леса и других материалов

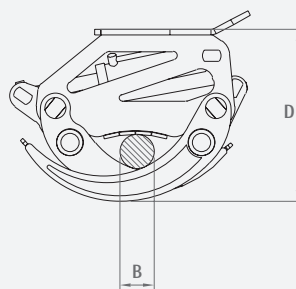
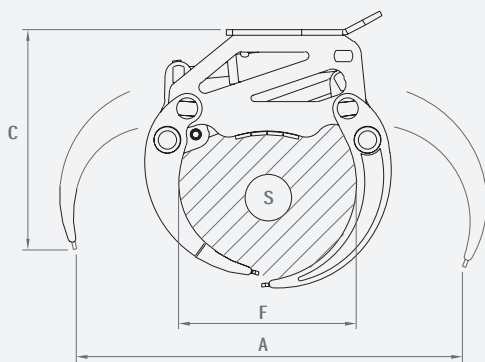

Modello	Area	Portata	Peso	Pressione	Portata olio	Dimensioni					
Model	Surface	Lifting capacity	Weight	Pressure	Oil flow	Sizes					
Modèle	Surface	Portée	Poids	Pression	Débit d'huile	Dimensions					
Modell	Oberfläche	Tragkraft	Gewicht	Druck	Ölleistung	Abmessungen					
	S - m ²	Kg	kg	bar	l/min	A	B	C	D	L	F
R50/225	0,2	800	115	220	40	1170	60	630	460	370	470
R50/375	0,3	1400	210	250	60	1400	130	860	620	380	640
R50/427	0,4	2000	250	300	50	1910	130	790	620	530	710